

GTMR 336 B

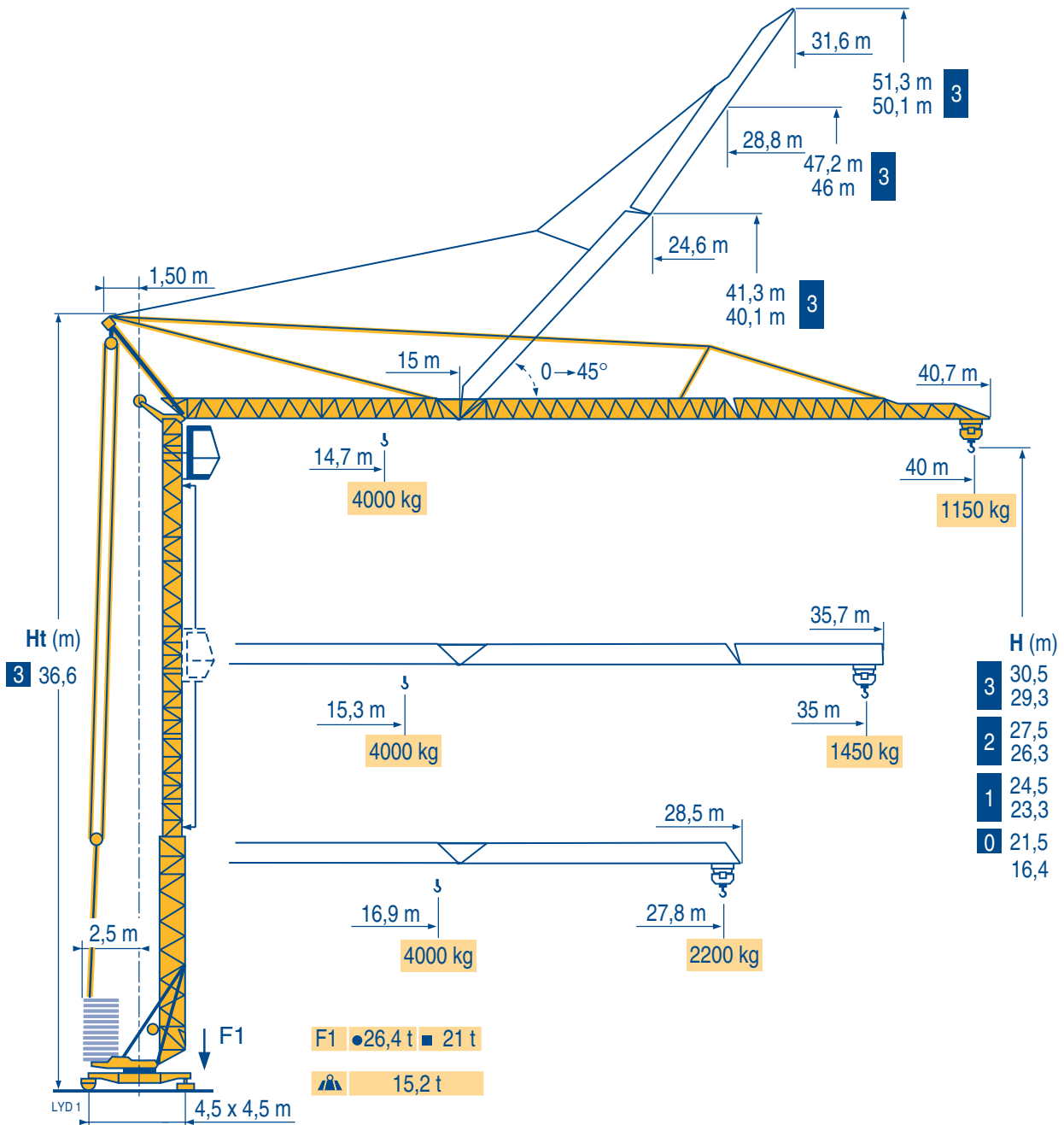

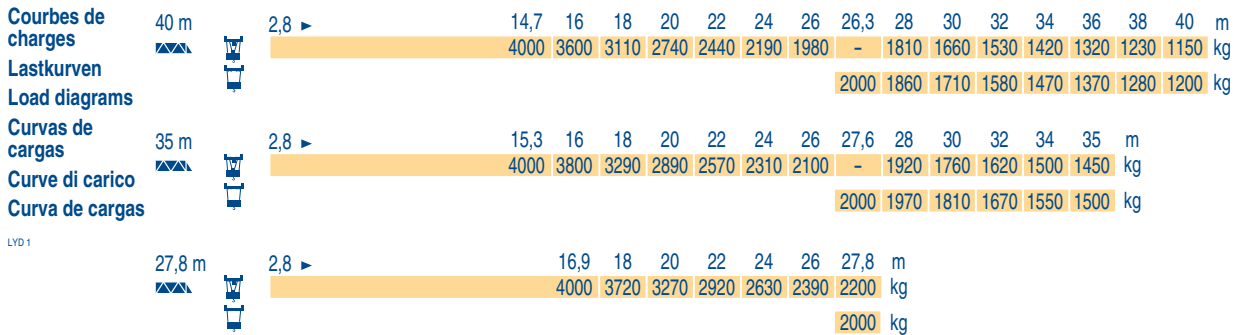

Flèche relevée
Ausleger in Steilstellung
Luffing jib
Flecha izada
Braccio impennato
Lança inclinada

LVD 1

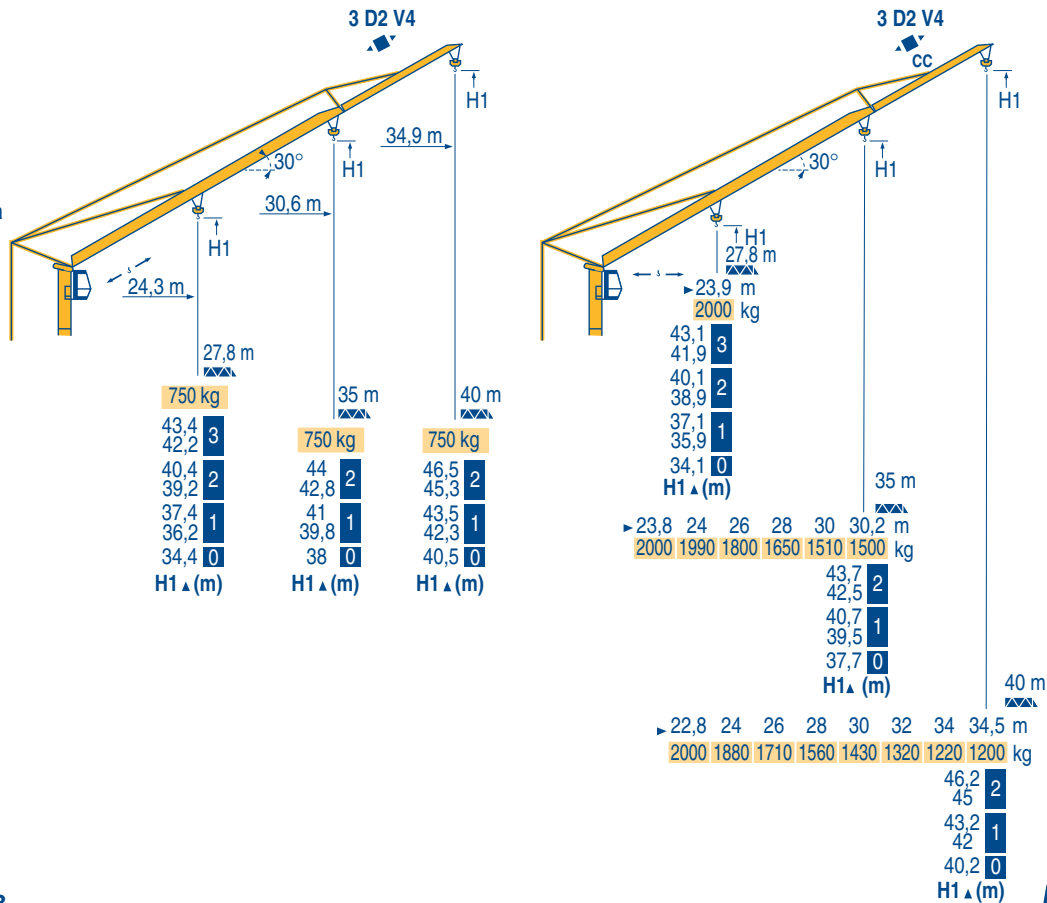

















GTMR 336 B

POTAIN

	F Chariot distributeur Chariot distributeur et courbes de charges Réactions en service Réactions hors service A vide sans lest (ni train de transport) avec flèche et hauteur maximum.		D Verfahrbare Laufkatze Verfahrbare Laufkatze und Lastkurven Reaktionskräfte in Betrieb Reaktionskräfte außer Betrieb Ohne Last, Ballast (und Transportachse), mit Maximalausleger und Maximalhöhe.		GB Traversing trolley Traversing trolley and load diagrams Reactions in service Reactions out of service Without load, ballast (or transport axes), with maximum jib and maximum height.		E Carro distribuidor Carro distribuidor y curvas de cargas Reacciones en servicio Reacciones fuera de servicio Sin carga, sin lastre, (ni tren de transporte), flecha y altura máxima.		I Carrellino distributore Carrellino distributore e curve di carico Reazioni in servizio Reazioni fuori servizio A vuoto, senza zavorra (ne assali di trasporto) con braccio massimo e altezza massima.		P Carro distribuidor Carro distribuidor e curva de cargas Reações em serviço Reações fora de serviço Sem carga (nem trem de transporte) - sem lastro com lança e altura máximas.
--	--	--	---	--	--	--	--	--	---	--	--

Mécanismes
Antriebe
Mechanisms
Meccanismi
Mecanismos

LYD 1

									ch - PS hp	kW
										
	20 TDPC 10	m/min	8	25	50	4	12,5	25	20	15
		kg	2000	2000	1300	4000	4000	2600		
	20 LVF 10	m/min	5	25	50	2,5	12,5	25	20	15
		kg	2000	2000	1300	4000	4000	2600		
	3 D2 V4	m/min	22 - 44						4	3
	RCV 32	tr/min U/min rpm	0 → 0,8						4	3
	TVD 122	m/min	25						2 x 2	2 x 1,5
 R ≥ 8 m	TB 122	m/min	25						2 x 2	2 x 1,5
CEI 38		 IEC 38								
400 V (+6% -10%) 50 Hz			25 kVA				2000/14			





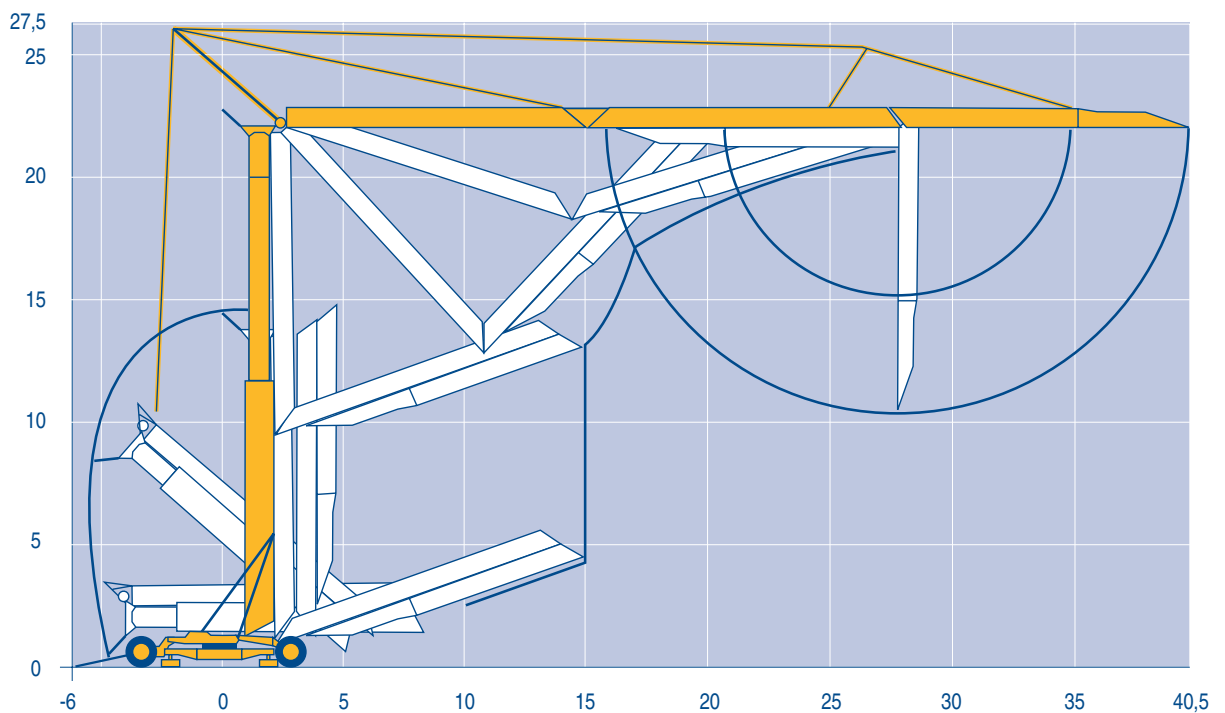

























Montage
Montage
Erection
Montaje
Montaggio
Montagem

LYD 1



GTMR 336 B

POTAIN 

F	D	GB	E	I	P
 Levage	 Heben	 Hoisting	 Elevación	 Sollevamento	 Elevação
 Distribution	 Katzfahren	 Trolleying	 Distribución	 Distribuzione	 Distribuição
 Orientation	 Schwenken	 Slewing	 Orientación	 Rotazione	 Rotação
 Translation	 Kranfahren	 Travelling	 Traslación	 Traslazione	 Translação
 Conforme aux directives CEE sur le niveau acoustique	 Gemäss EWG-Richtlinien für den Schall-Leistungspegel	 In compliance with the EEC Instructions on noise level	 Conforme con las directivas CEE sobre el nivel acústico	 Conforme alle direttive CEE sul livello acustico	 Conforme as directivas CEE sobre o nível acústico

Transport
 Transport
 Transport
 Transporte
 Trasporto
 Transporte

15A/25A

DJ126M/S215M

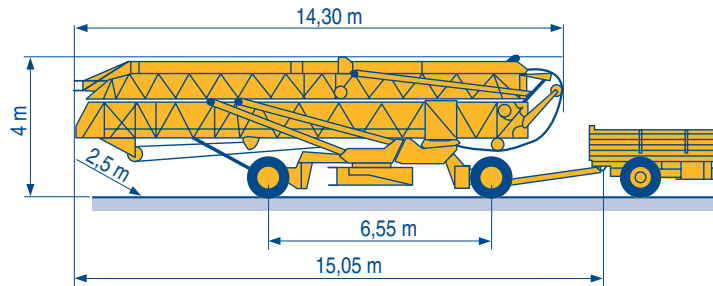

S4/S215M

S5B/J215M

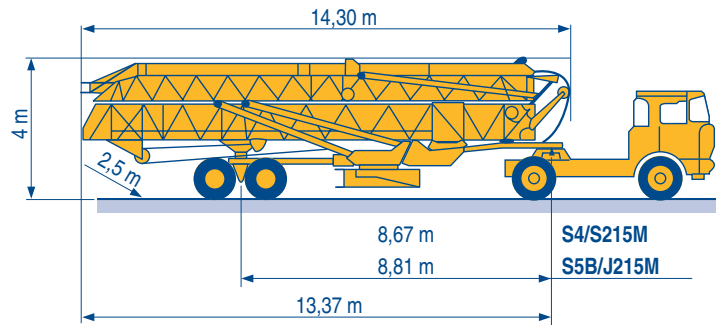

Document commercial non contractuel. Pour toute information technique se référer à la notice correspondante

Unverbindliches Vertriebsdokument. Für technische Informationen, siehe die entsprechenden Anweisungen.

This commercial document is not legally binding. For any technical information, please refer to the corresponding instructions.

Documento comercial no contractuel. Para cualquier información técnica, ver la noticia correspondiente.

Documento commerciale non vincolante, per tutte le informazioni tecniche fare riferimento al catalogo istruzioni

Documento comercial não contractual. Para qualquer informação técnica complementar consultar as respectivas instruções



18, rue de Charbonnières - B.P.173
 69132 ECULLY Cedex - France

Tél. : (33) 4 72 18 20 20
 Fax. : (33) 4 72 18 20 00
 www.manitowoccrane.com www.potain.com



Americas

Tel : +1 920 683 6322
 Tel : +1 717 597 8121

Europe - Middle East - Africa

Tel : +(33) 4 72 81 50 00
 Tel : +(44) 191 565 6281

Asia - Pacific

Tel : +(65) 6861 7133
 Fax : +(65) 6862 4142

www.manitowoccrane.com

GTMR 336 B

Réf. 2003 48 LYD 1

Copyright.Reproduction interdite © POTAIN 2003

Réalisation HeadLines